



PIHER®

ISO 9001
ISO 14001

MULTICLAMPS





Multiclamp

COD	 mm	 mm	kg	
34052	50	18-48	0.22	1





Multiclamp crochet



COD	 mm	 mm	kg	
34044	40	18-40	0.23	1

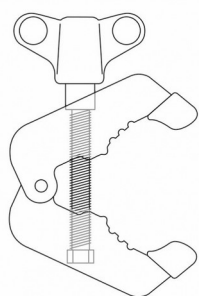

Multiclamp anneau

COD	 mm	 mm	kg	
34046	40	18-48	0.23	1



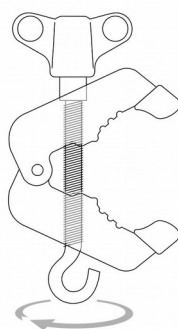

 Ø 18-48mm
3/4"-1 7/8"
 0-50mm
0-1 7/8"



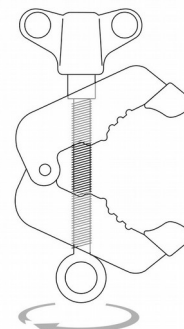

 Ø 18-30mm
 0-30mm



 Ø 18-30mm
3/4"-1 1/6"
 0-30mm
0-1 1/6"



COD	 mm	 mm	kg	
34048	50	18-48	0.38	1

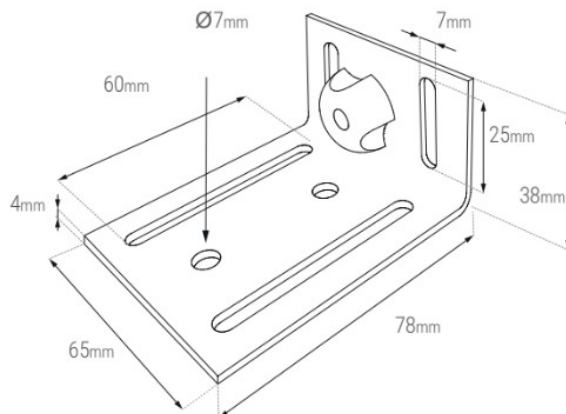

Multiclamp base réglable

CARACTÉRISTIQUES

- Plusieurs trous de vis et d'écrous M6, M8 et W1/4"
- Mâchoires en nylon fibre de verre
- Pression maximale: 150 kg
- Pour surfaces planes et profilées, tubes
- Mâchoires antidérapantes
- Vis, axe et renforts en acier
- Utilisable sur tous les diamètres

MATÉRIAUX ET FINITIONS

TOUTES LES MATIÈRES PREMIÈRES QU'UTILISE INDUSTRIAS PIQUERAS, S.A PROVIENNENT DE PAYS DE L'UNION EUROPÉENNE, ce qui assure une qualité maximale et facilite leurs contrôle et suivi.

PACKAGING ET ETIQUETAGE

1u/colis
Étiquette avec code EAN- 13

RÉGLEMENTATION EN VIGUEUR

Pas de norme de sécurité en vigueur
Industrias Piqueras travaille selon les normes de qualité ISO:9001 et ISO:14001.